



Serrature da infilare a cilindro
Mortice locks for profile cylinder



2200

Serie
2200



Serrature da infilare a cilindro
Mortice locks for profile cylinder

Stacco maniglia 72mm (GIALLO) - 85mm (VERDE) - 90mm (NERO)
 Handle Distance 72mm (YELLOW) - 85mm (GREEN) - 90mm (BLACK)

Rullo registrabile
 Adjustable roller



Scrocco reversibile
 Reversible latch



Fori passanti interasse DIN per l'applicazione
 di placche maniglia e rosette
 Through holes, DIN standard, to apply handles
 plates and roses

Entrate standard da 40mm a 80mm
 Standard backset from 40mm to 80mm

Catenaccio antifrapporto con spine antitaglio
 Anti-tamper proof and anti-saw dead bolt



Frontale Ottone 22mm - Bordo quadro o Tondo
 Brass frontal plate 22mm - Square or Round edge



Azionamento a cilindro, Quadro 8mm, Chiave patent
 Cylinder movement, square hole 8mm, patent key



Serie
2200



Serrature da infilare a cilindro
 Mortice locks for profile cylinder

2200/85-2205/85

Catenaccio Antistrappo e Scrocco

1-2 Mandate

Azionamento a cilindro

FINITURA DI SERIE

- Piastra frontale, Catenaccio, Scrocco OLV

DOTAZIONE

- Contropiastra con aletta Art. 357 OLV
- Viti di fissaggio
- CILINDRO ESCLUSO

Tamper proof bolt and latch

1-2 Turns

Cylinder movement

STANDARD FINISHINGS

- Front plate, Bolt, Latch OLV

ACCESSORIES

- Striking plate with tab Art. 357 OLV
- Fixing screws
- CYLINDER NOT INCLUDED

Serie **2200**



Serrature da infilare a cilindro
Morice locks for profile cylinder

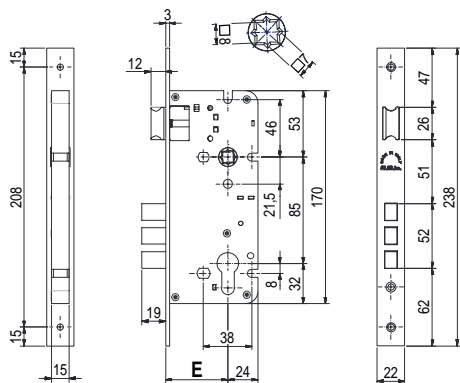

2200/85
2205/85

Catenaccio Antistrappo e Scrocco | 1-2 Mandate | Azionamento a cilindro

Tamper proof bolt and latch | 1-2 Turns | Cylinder movement

Codice Code	Finitura Finishing						
02200 85 45 ___ 7							45
02200 85 50 ___ 7							50
02200 85 60 ___ 7		2					60
02200 85 70 ___ 7							70
02200 85 80 ___ 7			22x3x238	85			80
02205 85 45 ___ 7						1	20
02205 85 50 ___ 7							50
02205 85 60 ___ 7		1					60
02205 85 70 ___ 7							70
02205 85 80 ___ 7							80

Finiture Standard | Standard Finishings

Finiture Speciali | Special Finishings

Finitura Finishing	OLV	OS	OC OCS ONS	OB OGR OGM	PLO	AB SFE	OBL OBS	PVD	XSO INOX

T2200/85-T2205/85

Catenaccio Antistrappo e Scrocco

1-2 Mandate

Azionamento a cilindro

Bordo Tondo

FINITURA DI SERIE

- Piastra frontale, Catenaccio, Scrocco OLV

DOTAZIONE

- Contropiastra con aletta Art. T357 OLV

- Viti di fissaggio

- CILINDRO ESCLUSO

Tamper proof bolt and latch

1-2 Turns

Cylinder movement

Round Edge

STANDARD FINISHINGS

- Front plate, Bolt, Latch OLV

ACCESSORIES

- Striking plate with tab Art. T357 OLV

- Fixing screws

- CYLINDER NOT INCLUDED

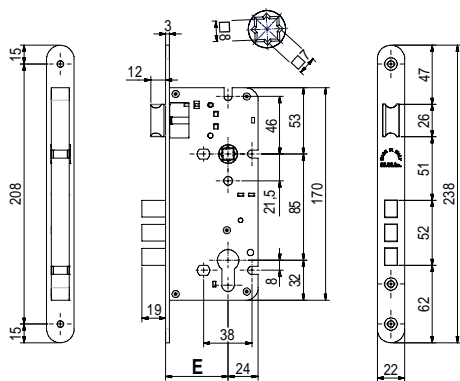

**T2200/85
T2205/85**

Catenaccio Antistrappo e Scrocco | 1-2 Mandate | Azionamento a cilindro | Bordo Tondo

Tamper proof bolt and latch | 1-2 Turns | Cylinder movement | Round Edge

Codice Code	Finitura Finishing							
T2200 85 45	7							45
T2200 85 50	7							50
T2200 85 60	7	2						60
T2200 85 70	7							70
T2200 85 80	7		22x3x238					80
T2205 85 45	7			85			1	45
T2205 85 50	7							50
T2205 85 60	7	1						60
T2205 85 70	7							70
T2205 85 80	7							80

Finitura
Finishing

Finiture Standard | Standard Finishings

Finiture Speciali | Special Finishings

OLV	OS	OCL OCS ONS	OB OGR OGM	PLO	AB SFE	OBL OBS	PVD	XSO INOX

Serie
2200



Serrature da infilare a cilindro
Morice locks for profile cylinder

2210/85-2215/85

Catenaccio e Scrocco
1-2 Mandate
Azionamento a cilindro

FINITURA DI SERIE

- Piastra frontale, Catenaccio, Scrocco OLV

DOTAZIONE

- Contropiastra con aletta Art. 357 OLV
- Viti di fissaggio
- CILINDRO ESCLUSO

Bolt and Latch
1-2 Turns
Cylinder movement

STANDARD FINISHINGS

- Front plate, Bolt, Latch OLV

ACCESSORIES

- Striking plate with tab Art. 357 OLV
- Fixing screws
- CYLINDER NOT INCLUDED

Serie **2200**

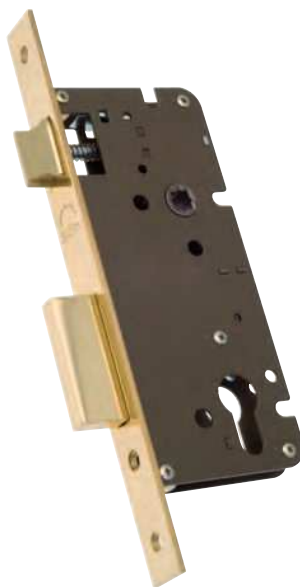

Serrature da infilare a cilindro
Morice locks for profile cylinder

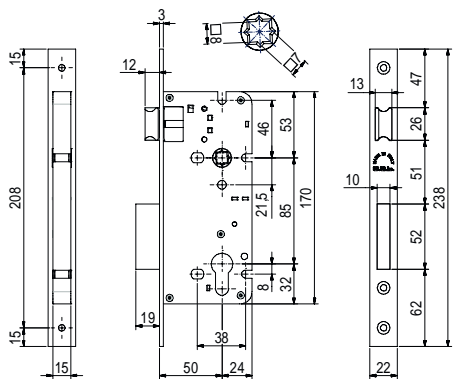

2210/85
2215/85

Catenaccio e Scrocco | 1-2 Mandate | Azionamento a cilindro
Bolt and Latch | 1-2 Turns | Cylinder movement

Codice Code	Finitura Finishing	2	22x3x238	85	1	20
02210 85 40 ___ 7						
02210 85 45 ___ 7						
02210 85 50 ___ 7						
02210 85 60 ___ 7						
02210 85 70 ___ 7						
02210 85 80 ___ 7						
02215 85 40 ___ 7						
02215 85 45 ___ 7						
02215 85 50 ___ 7						
02215 85 60 ___ 7						
02215 85 70 ___ 7						
02215 85 80 ___ 7						

Finiture Standard | Standard Finishings

Finiture Speciali | Special Finishings

Finitura Finishing	OLV	OS	OCL OCS ONS	OB OGR OGM	PLO	AB SFE	OBL OBS	PVD	XSO INOX

T2210/85-T2215/85

Catenaccio e Scrocco
1-2 Mandate
Azionamento a cilindro
Bordo Tondo

FINITURA DI SERIE

→ Piastra frontale, Catenaccio, Scrocco OLV

DOTAZIONE

→ Contropiastra con aletta Art. T357 OLV
→ Viti di fissaggio
→ CILINDRO ESCLUSO

Bolt and Latch
1-2 Turns
Cylinder movement
Round Edge

STANDARD FINISHINGS

→ Front plate, Bolt, Latch OLV

ACCESSORIES

→ Striking plate with tab Art. T357 OLV
→ Fixing screws
→ CYLINDER NOT INCLUDED

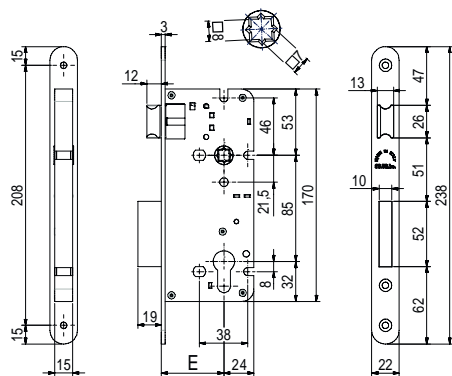

**T2210/85
T2215/85**

Catenaccio e Scrocco | 1-2 Mandate | Azionamento a cilindro | Bordo Tondo
Bolt and Latch | 1-2 Turns | Cylinder movement | Round Edge

Codice Code	Finitura Finishing					
T2210 85 40	7					40
T2210 85 45	7					45
T2210 85 50	7					50
T2210 85 60	7	2				60
T2210 85 70	7					70
T2210 85 80	7					80
T2215 85 40	7		22x3x238	85		40
T2215 85 45	7				1	45
T2215 85 50	7					50
T2215 85 60	7	1				60
T2215 85 70	7					70
T2215 85 80	7					80

Finitura Finishing	Finiture Standard Standard Finishings				Finiture Speciali Special Finishings				
	OLV	OS	OCL OCS ONS	OB OGR OGM	PLO	AB SFE	OBL OBS	PVD	XSO INOX

Serie
2200



Serrature da infilare a cilindro
Morice locks for profile cylinder

2100-2105

Catenaccio Antistrappo
1-2 Mandate
Azionamento a cilindro

FINITURA DI SERIE

- Piastra frontale, Catenaccio OLV

DOTAZIONE

- Contropiastra Art. 354 OLV
- Viti di fissaggio
- CILINDRO ESCLUSO

Tamper proof bolt
1-2 Turns
Cylinder movement

STANDARD FINISHINGS

- Front plate, Bolt OLV

ACCESSORIES

- Striking plate Art. 354 OLV
- Fixing screws
- CYLINDER NOT INCLUDED

Serie **2200**



Serrature da infilare a cilindro
Morice locks for profile cylinder

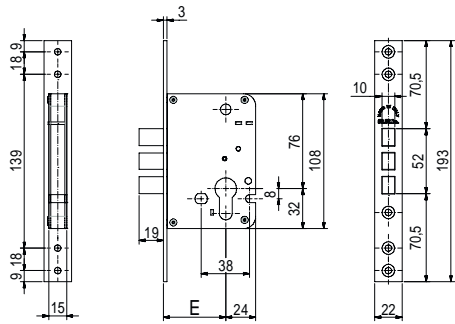

2100 Catenaccio Antistrappo | 1-2 Mandate | Azionamento a cilindro
2105

Tamper proof bolt | 1-2 Turns | Cylinder movement

Codice Code	Finitura Finishing	2	1	1	25
02100 45	4			45	
02100 50	4			50	
02100 60	4			60	
02100 70	4			70	
02100 80	4	22x3x193		80	
02105 45	4			45	
02105 50	4			50	
02105 60	4		1	60	
02105 70	4			70	
02105 80	4			80	

Finiture Standard | Standard Finishings

Finiture Speciali | Special Finishings

Finitura Finishing	OLV	OS	OC OCS ONS	OB OGR OGM	PLO	AB SFE	OBL OBS	PVD	XSO INOX

T2100-T2105

Catenaccio Antistrappo
1-2 Mandate
Azionamento a cilindro
Bordo Tondo

FINITURA DI SERIE

→ Piastra frontale, Catenaccio OLV

DOTAZIONE

→ Contropiastra Art. T354 OLV
→ Viti di fissaggio
→ CILINDRO ESCLUSO

Tamper proof bolt
1-2 Turns
Cylinder movement
Round Edge

STANDARD FINISHINGS

→ Front plate, Bolt OLV

ACCESSORIES

→ Striking plate Art. T354 OLV
→ Fixing screws
→ CYLINDER NOT INCLUDED

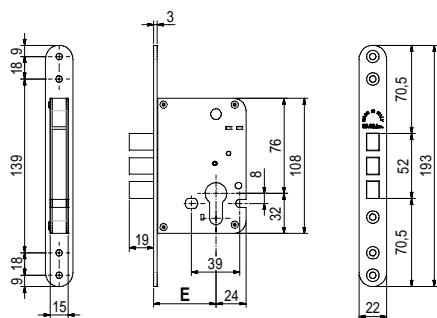

**T2100
T2105**

Catenaccio Antistrappo | 1-2 Mandate | Azionamento a cilindro | Bordo Tondo

Tamper proof bolt | 1-2 Turns | Cylinder movement | Round Edge

Codice Code	Finitura Finishing	Icona 1	Icona 2	Icona 3	Icona 4	Icona 5
T2100 45	4					45
T2100 50	4					50
T2100 60	4	2				60
T2100 70	4					70
T2100 80	4					80
T2105 45	4		22x3x193		1	45
T2105 50	4					50
T2105 60	4	1				60
T2105 70	4					70
T2105 80	4					80

Finiture Standard | Standard Finishings

Finiture Speciali | Special Finishings

Finitura Finishing	OLV	OS	OC OC ONS	OB OGR OGM	PLO	AB SFE	OBL OBS	PVD	XSO INOX

Serie
2200



Serrature da infilare a cilindro
Morice locks for profile cylinder

2110-2115

Solo Catenaccio
1-2 Mandate
Azionamento a cilindro

FINITURA DI SERIE

- Piastra frontale, Catenaccio OLV

DOTAZIONE

- Contropiastra Art. 354 OLV
- Viti di fissaggio
- **CILINDRO ESCLUSO**

Bolt only
1-2 Turns
Cylinder movement

STANDARD FINISHINGS

- Front plate, Bolt OLV

ACCESSORIES

- Striking plate Art. 354 OLV
- Fixing screws
- **CYLINDER NOT INCLUDED**

Serie **2200**



Serrature da infilare a cilindro
Morice locks for profile cylinder

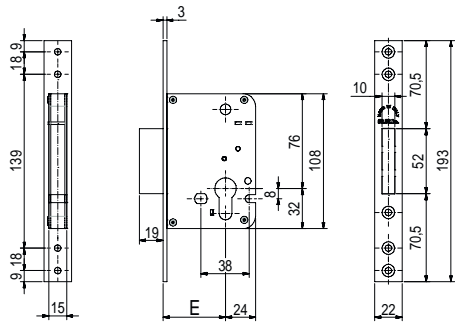

2110 Solo Catenaccio | 1-2 Mandate | Azionamento a cilindro
2115 Bolt only | 1-2 Turns | Cylinder movement

Codice Code	Finitura Finishing	2	1	1	25
02110 40	4			40	
02110 45	4			45	
02110 50	4			50	
02110 60	4			60	
02110 70	4			70	
02110 80	4			80	
02115 40	4	22x3x193		40	1
02115 45	4			45	
02115 50	4			50	
02115 60	4		1	60	
02115 70	4			70	
02115 80	4			80	

Finiture Standard | Standard Finishings

Finiture Speciali | Special Finishings

Finitura Finishing	OLV	OS	OCL OCS ONS	OB OGR OGM	PLO	AB SFE	OBL OBS	PVD	XSO INOX

T2110-T2115

Solo Catenaccio
1-2 Mandate
Azionamento a cilindro
Bordo Tondo

FINITURA DI SERIE

→ Piastra frontale, Catenaccio OLV

DOTAZIONE

→ Contropiastra Art. T354 OLV
→ Viti di fissaggio
→ CILINDRO ESCLUSO

Bolt only
1-2 Turns
Cylinder movement
Round Edge

STANDARD FINISHINGS

→ Front plate, Bolt OLV

ACCESSORIES

→ Striking plate Art. T354 OLV
→ Fixing screws
→ CYLINDER NOT INCLUDED

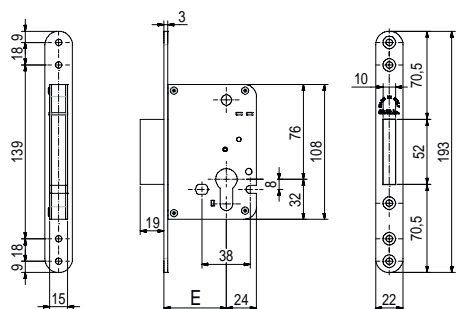

T2110 T2115

Solo Catenaccio | 1-2 Mandate | Azionamento a cilindro | Bordo Tondo

Bolt only | 1-2 Turns | Cylinder movement | Round Edge

Codice Code	Finitura Finishing					
T2110 40	4					40
T2110 45	4					45
T2110 50	4					50
T2110 60	4					60
T2110 70	4					70
T2110 80	4					80
T2115 40	4		22x3x193		1	25
T2115 45	4					45
T2115 50	4					50
T2115 60	4					60
T2115 70	4					70
T2115 80	4					80

Finitura Finishing	Finiture Standard Standard Finishings				Finiture Speciali Special Finishings				
	OLV	OS	OCL OCS ONS	OB OGR OGM	PLO	AB SFE	OBL OBS	PVD	XSO INOX

Serie
2200



Serrature da infilare a cilindro
Morice locks for profile cylinder

2150

Solo Scrocco

FINITURA DI SERIE

- Piastra frontale, Scrocco OLV

DOTAZIONE

- Contropiastra con aletta Art. 355 OLV
- Viti di fissaggio

Latch only

STANDARD FINISHINGS

- Front plate, Latch OLV

ACCESSORIES

- Striking plate with tab Art. 355 OLV
- Fixing screws



Serie **2200**





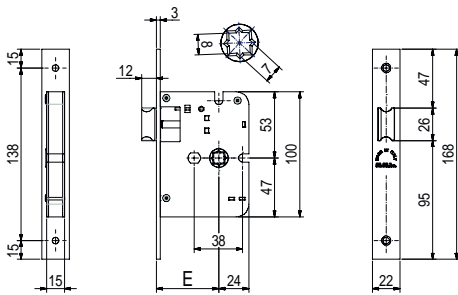

Serrature da infilare a cilindro
Morice locks for profile cylinder



2150

Solo Scrocco

Latch only

Codice Code	Finitura Finishing				
02150 40	5	22x3x168	40	1	25
02150 45	5		45		
02150 50	5		50		
02150 60	5		60		
02150 70	5		70		
02150 80	5		80		

Finitura Finishing	Finiture Standard Standard Finishings				Finiture Speciali Special Finishings				
	OLV	OS	OCL OCS ONS	OB OGR OGM	PLO	AB SFE	OBL OBS	PVD	XSO INOX

T2150

Solo Scrocco
Bordo Tondo

FINITURA DI SERIE

- Piastra frontale, Scrocco OLV

DOTAZIONE

- Contropiastra con aletta Art. T355 OLV
- Viti di fissaggio

Latch only
Round Edge

STANDARD FINISHINGS

- Front plate, Latch OLV

ACCESSORIES



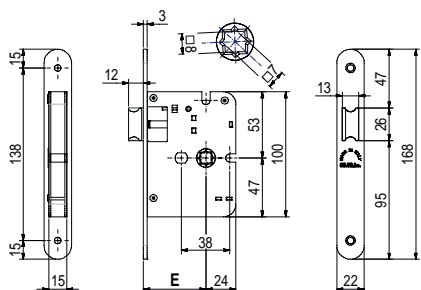
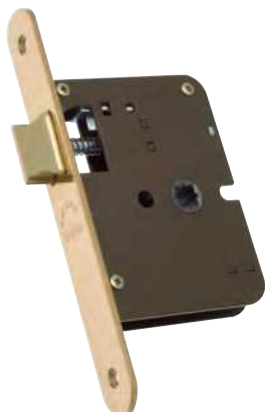

- Striking plate with tab Art. T355 OLV
- Fixing screws



T2150

Solo Scrocco | Bordo Tondo

Latch only | Round Edge

Codice Code	Finitura Finishing				
T2150 40	5	22x3x168	40		
T2150 45	5		45		
T2150 50	5		50		
T2150 60	5		60	1	25
T2150 70	5		70		
T2150 80	5		80		

Finiture Standard | Standard Finishings

Finitura
Finishing

OLV	OS	OCL OCS ONS	OB OGR OGM	PLO	AB SFE	OBL OBS	PVD	XSO INOX

Finiture Speciali | Special Finishings

Serie
2200



Serrature da infilare a cilindro
Morice locks for profile cylinder

2160

Solo Scrocco

FINITURA DI SERIE

- Piastra frontale, Scrocco OLV

DOTAZIONE

- Contropiastra con aletta Art. 357S OLV
- Viti di fissaggio

Latch only

STANDARD FINISHINGS

- Front plate, Latch OLV

ACCESSORIES

- Striking plate with tab Art. 357S OLV
- Fixing screws



Serie **2200**





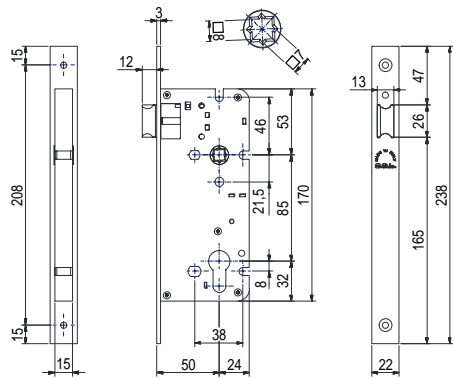

Serrature da infilare a cilindro
Morice locks for profile cylinder



2160

Solo Scrocco

Latch only

Codice Code	Finitura Finishing				
02160 40	5	22x3x238	40	1	20
02160 45	5		45		
02160 50	5		50		
02160 60	5		60		
02160 70	5		70		
02160 80	5		80		

Finiture Standard | Standard Finishings

Finiture Speciali | Special Finishings

Finitura Finishing	OLV	OS	COL OCS ONS	OB OGR OGM	PLO	AB SFE	OBL OBS	PVD	XSO INOX

T2160

Solo Scrocco
Bordo Tondo

FINITURA DI SERIE

- Piastra frontale, Scrocco OLV

DOTAZIONE

- Contropiastra con aletta Art. T357S OLV
- Viti di fissaggio

Latch only
Round Edge

STANDARD FINISHINGS

- Front plate, Latch OLV

ACCESSORIES



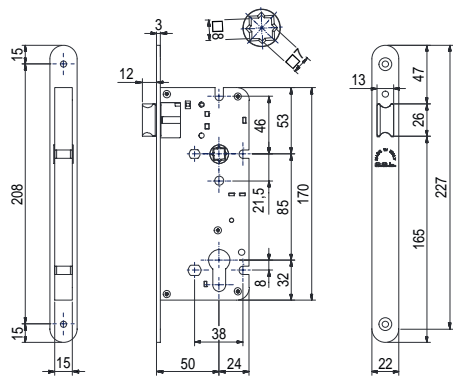

- Striking plate with tab Art. T357S OLV
- Fixing screws



T2160

Solo Scrocco | Bordo Tondo

Latch only | Round Edge

Codice Code	Finitura Finishing				
T2160 40	5	22x3x238	40	1	20
T2160 45	5		45		
T2160 50	5		50		
T2160 60	5		60		
T2160 70	5		70		
T2160 80	5		80		

Finiture Standard | Standard Finishings

Finiture Speciali | Special Finishings

Finitura Finishing	OLV	OS	OCL OCS ONS	OB OGR OGM	PLO	AB SFE	OBL OBS	PVD	XSO INOX

Serie
2200



Serrature da infilare a cilindro
Morice locks for profile cylinder

2216/85

Serratura per bagno
 Doppio quadro 8mm
 Catenaccio e Scrocco
 1 Mandata
 Azionamento quadro 8mm

FINITURA DI SERIE

- Piastra frontale, Catenaccio, Scrocco OLV

DOTAZIONE

- Contropiastra con aletta Art. 357 OLV
- Viti di fissaggio

Bathroom lock
 Double square hole 8mm
 Bolt and Latch
 1 Turn
 Square hole movement

STANDARD FINISHINGS

- Front plate, Bolt, Latch OLV

ACCESSORIES

- Striking plate with tab Art. 357 OLV
- Fixing screws

Serie **2200**



Serrature da infilare a cilindro
 Mortice locks for profile cylinder

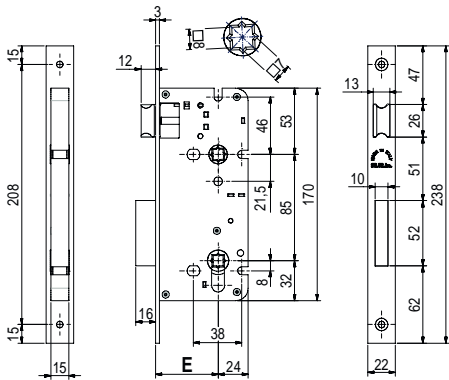
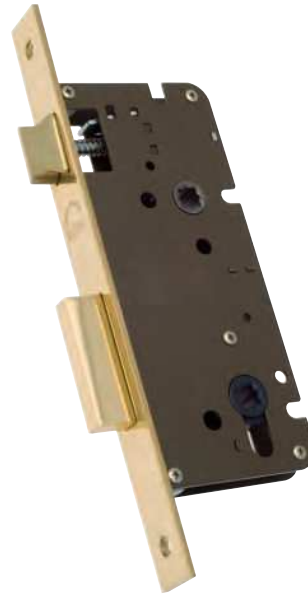

2216/85

Serratura per bagno | Doppio quadro 8mm | Catenaccio e Scrocco | 1 Mandata | Azionamento quadro 8mm

Bathroom lock | Double square hole 8mm | Bolt and Latch | 1 Turn | Square hole movement

Codice Code	Finitura Finishing					
02216 85 40 ___ 7	---					
02216 85 45 ___ 7	---					
02216 85 50 ___ 7	---					
02216 85 60 ___ 7	---	1	22x3x238	85		1 20
02216 85 70 ___ 7	---					
02216 85 80 ___ 7	---					

Finiture Standard | Standard Finishings

Finiture Speciali | Special Finishings

Finitura Finishing	OLV	OS	OCL OCS ONS	OB OGR OGM	PLO	AB SFE	OBL OBS	PVD	XSO INOX

T2216/85

Serratura per bagno
Doppio quadro 8mm
Catenaccio e Scrocco
1 Mandata
Azionamento quadro 8mm | Bordo Tondo

FINITURA DI SERIE

– Piastra frontale, Catenaccio, Scrocco OLV

DOTAZIONE

– Contropiastra con aletta Art. T357 OLV
– Viti di fissaggio

Bathroom lock
Double square hole 8mm
Bolt and Latch
1 Turn
Square hole movement | Round Edge

STANDARD FINISHINGS

– Front plate, Bolt, Latch OLV





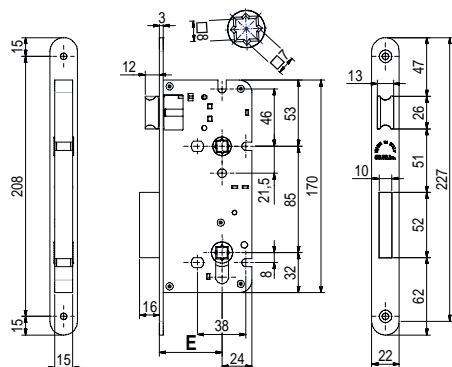
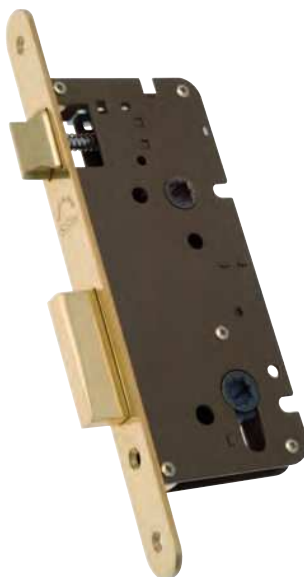

ACCESSORIES

– Striking plate with tab Art. T357 OLV
– Fixing screws



T2216/85

Serratura per bagno | Doppio quadro 8mm | Catenaccio e Scrocco | 1 Mandata | Azionamento quadro 8mm | Bordo Tondo
Bathroom lock | Double square hole 8mm | Bolt and Latch | 1 Turn | Square hole movement | Round Edge

Codice Code	Finitura Finishing						
T2216 85 40	___ 7						
T2216 85 45	___ 7						
T2216 85 50	___ 7						
T2216 85 60	___ 7	1	22x3x238	85		1	20
T2216 85 70	___ 7						
T2216 85 80	___ 7						

Finiture Standard | Standard Finishings

Finitura
Finishing

OLV	OS	OCL OCS ONS	OB OGR OGM	PLO	AB SFE	OBL OBS	PVD	XSO INOX

Finiture Speciali | Special Finishings

Serie
2200



Serrature da infilare a cilindro
Morice locks for profile cylinder

2116

Serratura per bagno
 Quadro 8mm
 Solo Catenaccio
 1 Mandata
 Azionamento quadro 8mm

FINITURA DI SERIE

- Piastra frontale, Catenaccio OLV

DOTAZIONE

- Contropiastra Art. 354 OLV
- Viti di fissaggio

Bathroom lock
 Square hole 8mm
 Bolt only
 1 Turn
 Square hole movement

STANDARD FINISHINGS

- Front plate, Bolt OLV

ACCESSORIES

- Striking plate Art. 354 OLV
- Fixing screws



Serie **2200**



Serrature da infilare a cilindro
 Mortice locks for profile cylinder

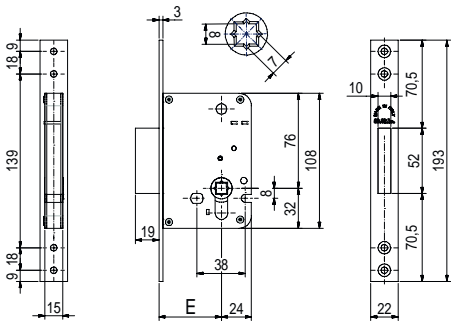

2116

Serratura per bagno | Quadro 8mm | Solo Catenaccio | 1 Mandata | Azionamento quadro 8mm
 Bathroom lock | Square hole 8mm | Bolt only | 1 Turn | Square hole movement

Codice Code	Finitura Finishing					
02116 40	4			40		
02116 45	4			45		
02116 50	4			50		
02116 60	4	1	22x3x193	60	1	25
02116 70	4			70		
02116 80	4			80		

Finiture Standard | Standard Finishings

Finiture Speciali | Special Finishings

Finitura Finishing	OLV	OS	COL OCS ONS	OB OGR OGM	PLO	AB SFE	OBL OBS	PVD	XSO INOX

T2116

Serratura per bagno
 Quadro 8mm
 Solo Catenaccio
 1 Mandata
 Azionamento quadro 8mm | Bordo Tondo

FINITURA DI SERIE

- Piastra frontale, Catenaccio OLV

DOTAZIONE

- Contropiastra Art. T354 OLV
- Viti di fissaggio

Bathroom lock
 Square hole 8mm
 Bolt only
 1 Turn
 Square hole movement | Round Edge

STANDARD FINISHINGS

- Front plate, Bolt OLV

ACCESSORIES

- Striking plate Art. T354 OLV
- Fixing screws

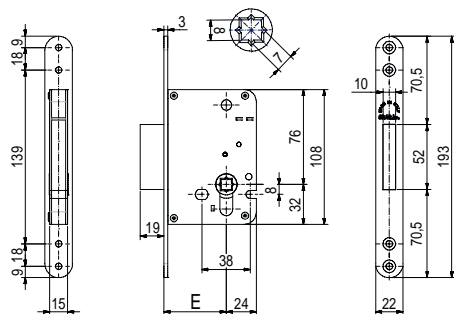

T2116

Serratura per bagno | Quadro 8mm | Solo Catenaccio | 1 Mandata | Azionamento quadro 8mm | Bordo Tondo

Bathroom lock | Square hole 8mm | Bolt only | 1 Turn | Square hole movement | Round Edge

Codice Code	Finitura Finishing					
T2116 40	4					40
T2116 45	4					45
T2116 50	4					50
T2116 60	4	1	22x3x193		1	60
T2116 70	4					70
T2116 80	4					80

Finiture Standard | Standard Finishings

Finitura Finishing

OLV	OS	OCL OCS ONS	OB OGR OGM	PLO	AB SFE	OBL OBS	PVD	XSO INOX

Finiture Speciali | Special Finishings

Serie
2200



Serrature da infilare a cilindro
 Mortice locks for profile cylinder

2202-2207

Catenaccio Antistrappo
 Rullo registrabile
 1-2 Mandate
 Azionamento a cilindro

FINITURA DI SERIE

- Piastra frontale, Catenaccio, Rullo OLV

DOTAZIONE

- Contropiastra con aletta Art. 357R OLV
- Viti di fissaggio
- CILINDRO ESCLUSO

Tamper proof bolt
 Adjustable roller
 1-2 Turns
 Cylinder movement

STANDARD FINISHINGS

- Front plate, Bolt, Roller OLV

ACCESSORIES

- Striking plate with tab Art. 357R OLV
- Fixing screws
- CYLINDER NOT INCLUDED

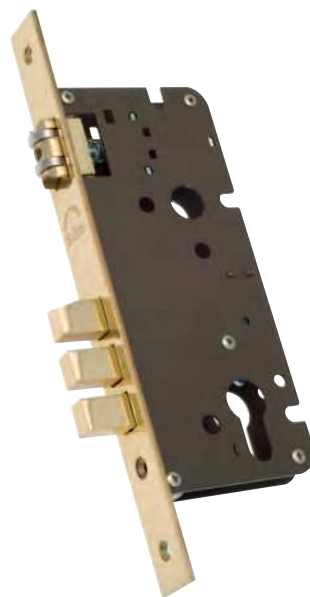

Serie 2200



Serrature da infilare a cilindro
 Mortice locks for profile cylinder

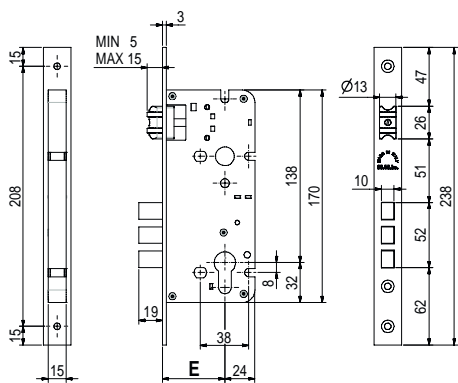

2202
2207

Catenaccio Antistrappo | Rullo registrabile | 1-2 Mandate | Azionamento a cilindro
 Tamper proof bolt | Adjustable roller | 1-2 Turns | Cylinder movement

Codice Code	Finitura Finishing					
02202 45 ___ 7					45	
02202 50 ___ 7					50	
02202 60 ___ 7		2			60	
02202 70 ___ 7					70	
02202 80 ___ 7			22x3x238		80	
02207 45 ___ 7					45	1
02207 50 ___ 7					50	
02207 60 ___ 7		1			60	
02207 70 ___ 7					70	
02207 80 ___ 7					80	20

Finiture Standard | Standard Finishings

Finiture Speciali | Special Finishings

Finitura Finishing	OLV	OS	OCL OCS ONS	OB OGR OGM	PLO	AB SFE	OBL OBS	PVD	XSO INOX

T2202-T2207

Catenaccio Antistrappo
Rullo registrabile
1-2 Mandate
Azionamento a cilindro
Bordo Tondo

FINITURA DI SERIE

- Piastra frontale, Catenaccio, Rullo OLV

DOTAZIONE

- Contropiastra con aletta Art. T357R OLV
- Viti di fissaggio
- CILINDRO ESCLUSO

Tamper proof bolt
Adjustable roller
1-2 Turns
Cylinder movement
Round Edge

STANDARD FINISHINGS

- Front plate, Bolt, Roller OLV

ACCESSORIES

- Striking plate with tab Art. T357R OLV
- Fixing screws
- CYLINDER NOT INCLUDED

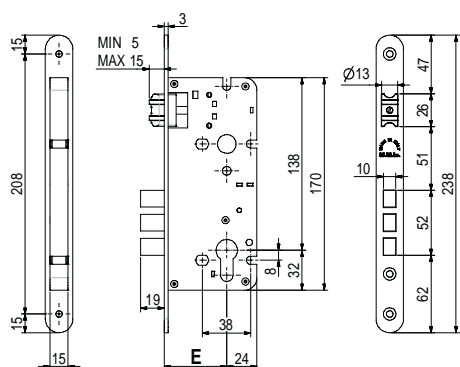

T2202 T2207

Catenaccio Antistrappo | Rullo registrabile | 1-2 Mandate | Azionamento a cilindro | Bordo Tondo

Tamper proof bolt | Adjustable roller | 1-2 Turns | Cylinder movement | Round Edge

Codice Code	Finitura Finishing					
T2202 45 ___ 7	---					45
T2202 50 ___ 7	---					50
T2202 60 ___ 7	---	2				60
T2202 70 ___ 7	---					70
T2202 80 ___ 7	---					80
T2207 45 ___ 7	---		22x3x238			45
T2207 50 ___ 7	---					50
T2207 60 ___ 7	---	1				60
T2207 70 ___ 7	---					70
T2207 80 ___ 7	---					80

Finiture Standard | Standard Finishings

Finitura
Finishing

OLV	OS	OCL OCS ONS	OB OGR OGM	PLO	AB SFE	OBL OBS	PVD	XSO INOX

Finiture Speciali | Special Finishings

Serie
2200



Serrature da infilare a cilindro
Morice locks for profile cylinder

2212-2217

Catenaccio
Rullo registrabile
1-2 Mandate
Azionamento a cilindro

FINITURA DI SERIE

- Piastra frontale, Catenaccio, Rullo OLV

DOTAZIONE

- Contropiastra con aletta Art. 357R OLV
- Viti di fissaggio
- **CILINDRO ESCLUSO**

Bolt
Adjustable roller
1-2 Turns
Cylinder movement

STANDARD FINISHINGS

- Front plate, Bolt, Roller OLV

ACCESSORIES

- Striking plate with tab Art. 357R OLV
- Fixing screws
- **CYLINDER NOT INCLUDED**

Serie **2200**



Serrature da infilare a cilindro
Morice locks for profile cylinder

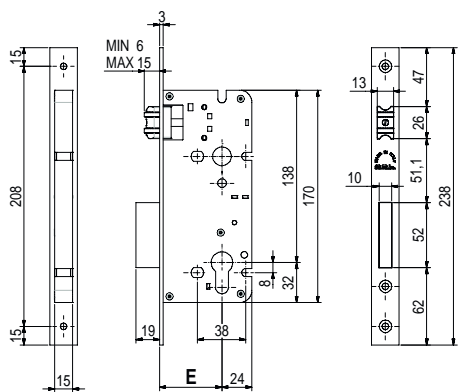

2212
2217

Catenaccio | Rullo registrabile | 1-2 Mandate | Azionamento a cilindro

Bolt | Adjustable roller | 1-2 Turns | Cylinder movement

Codice Code	Finitura Finishing					
02212 40 ___ 7						40
02212 45 ___ 7						45
02212 50 ___ 7						50
02212 60 ___ 7		2				60
02212 70 ___ 7						70
02212 80 ___ 7			22x3x238			80
02217 40 ___ 7					1	40
02217 45 ___ 7						45
02217 50 ___ 7		1				50
02217 60 ___ 7						60
02217 70 ___ 7						70
02217 80 ___ 7						80

Finiture Standard | Standard Finishings

Finiture Speciali | Special Finishings

Finitura Finishing	OLV	OS	OCL OCS ONS	OB OGR OGM	PLO	AB SFE	OBL OBS	PVD	XSO INOX

T2212-T2217

Catenaccio
Rullo registrabile
1-2 Mandate
Azionamento a cilindro
Bordo Tondo

FINITURA DI SERIE

– Piastra frontale, Catenaccio, Rullo OLV

DOTAZIONE

– Contropiastra con aletta Art. T357R OLV
– Viti di fissaggio
– CILINDRO ESCLUSO

Bolt
Adjustable roller
1-2 Turns
Cylinder movement
Round Edge

STANDARD FINISHINGS

– Front plate, Bolt, Roller OLV

ACCESSORIES

– Striking plate with tab Art. T357R OLV
– Fixing screws
– CYLINDER NOT INCLUDED

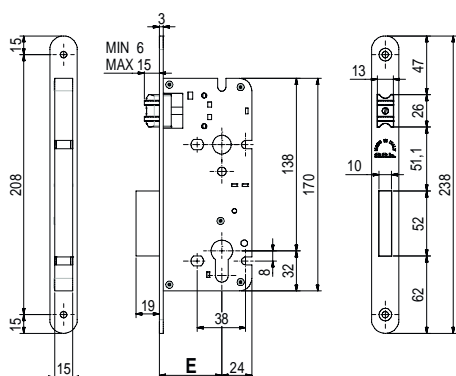

**T2212
T2217**

Catenaccio | Rullo registrabile | 1-2 Mandate | Azionamento a cilindro | Bordo Tondo
Bolt | Adjustable roller | 1-2 Turns | Cylinder movement | Round Edge

Codice Code	Finitura Finishing					
T2212 40 ___ 7	---				40	
T2212 45 ___ 7	---				45	
T2212 50 ___ 7	---				50	
T2212 60 ___ 7	---	2			60	
T2212 70 ___ 7	---				70	
T2212 80 ___ 7	---				80	
T2217 40 ___ 7	---		22x3x238		40	1 20
T2217 45 ___ 7	---				45	
T2217 50 ___ 7	---				50	
T2217 60 ___ 7	---	1			60	
T2217 70 ___ 7	---				70	
T2217 80 ___ 7	---				80	

Finitura Finishing	Finiture Standard Standard Finishings				Finiture Speciali Special Finishings				
	OLV	OS	OCL OCS ONS	OB OGR OGM	PLO	AB SFE	OBL OBS	PVD	XSO INOX

Serie
2200



Serrature da infilare a cilindro
Morice locks for profile cylinder

2200/90

Catenaccio Antistrappo e Scrocco
2 Mandate
Azionamento a cilindro

FINITURA DI SERIE

- Piastra frontale, Catenaccio, Scrocco OLV

DOTAZIONE

- Contropiastra con aletta Art. 357 OLV
- Viti di fissaggio
- CILINDRO ESCLUSO

Tamper proof bolt and latch
2 Turns
Cylinder movement

STANDARD FINISHINGS

- Front plate, Bolt, Latch OLV

ACCESSORIES

- Striking plate with tab Art. 357 OLV
- Fixing screws
- CYLINDER NOT INCLUDED



Serie **2200**



Serrature da infilare a cilindro
Morice locks for profile cylinder

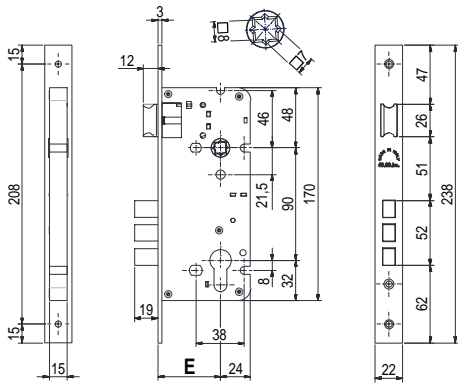

2200/90

Catenaccio Antistrappo e Scrocco | 2 Mandate | Azionamento a cilindro

Tamper proof bolt and latch | 2 Turns | Cylinder movement

Codice Code	Finitura Finishing						
02200 90 45 ___ 7	---				45		
02200 90 50 ___ 7	---	2	22x3x238	90	50	1	20
02200 90 60 ___ 7	---				60		
02200 90 70 ___ 7	---				70		

Finitura Finishing	Finiture Standard Standard Finishings				Finiture Speciali Special Finishings				
	OLV	OS	OC OC ONS	OB OGR OGM	PLO	AB SFE	OBL OBS	PVD	XSO INOX

T2200/90

Catenaccio Antistrappo e Scrocco

2 Mandate

Azionamento a cilindro

Bordo Tondo

FINITURA DI SERIE

→ Piastra frontale, Catenaccio, Scrocco OLV

DOTAZIONE

→ Contropiastra con aletta Art. T357 OLV

→ Viti di fissaggio

→ CILINDRO ESCLUSO

Tamper proof bolt and latch

2 Turns

Cylinder movement

Round Edge

STANDARD FINISHINGS

→ Front plate, Bolt, Latch OLV

ACCESSORIES

→ Striking plate with tab Art. T357 OLV

→ Fixing screws



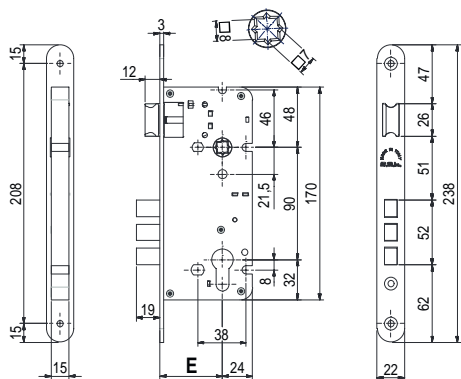



→ CYLINDER NOT INCLUDED



T2200/90

Catenaccio Antistrappo e Scrocco | 2 Mandate | Azionamento a cilindro | Bordo Tondo

Tamper proof bolt and latch | 2 Turns | Cylinder movement | Round Edge

Codice Code	Finitura Finishing						
T2200 90 45	7						45
T2200 90 50	7	2	22x3x238	90			50
T2200 90 60	7					1	60
T2200 90 70	7						70

Finitura
Finishing

Finiture Standard | Standard Finishings

Finiture Speciali | Special Finishings

OLV	OS	OCL OCS ONS	OB OGR OGM	PLO	AB SFE	OBL OBS	PVD	XSO INOX

Serie
2200



Serrature da infilare a cilindro
Morice locks for profile cylinder

2210/90

Catenaccio e Scrocco
2 Mandate
Azionamento a cilindro

FINITURA DI SERIE

- Piastra frontale, Catenaccio, Scrocco OLV

DOTAZIONE

- Contropiastra con aletta Art. 357 OLV
- Viti di fissaggio
- CILINDRO ESCLUSO

Bolt and Latch
2 Turns
Cylinder movement

STANDARD FINISHINGS

- Front plate, Bolt, Latch OLV

ACCESSORIES

- Striking plate with tab Art. 357 OLV
- Fixing screws
- CYLINDER NOT INCLUDED

Serie **2200**



Serrature da infilare a cilindro
Morice locks for profile cylinder

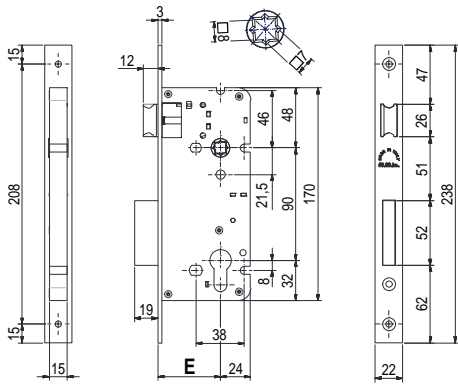

2210/90

Catenaccio e Scrocco | 2 Mandate | Azionamento a cilindro

Bolt and Latch | 2 Turns | Cylinder movement

Codice Code	Finitura Finishing					
02210 90 40 ___ 7	---					40
02210 90 45 ___ 7	---					45
02210 90 50 ___ 7	---	2	22x3x238	90		50
02210 90 60 ___ 7	---					60
02210 90 70 ___ 7	---					70

Finitura Finishing	Finiture Standard Standard Finishings				Finiture Speciali Special Finishings				
	OLV	OS	OC OCS ONS	OB OGR OGM	PLO	AB SFE	OBL OBS	PVD	XSO INOX

T2210/90

Catenaccio e Scrocco
2 Mandate
Azionamento a cilindro
Bordo Tondo

FINITURA DI SERIE

→ Piastra frontale, Catenaccio, Scrocco OLV

DOTAZIONE

→ Contropiastra con aletta Art. T357 OLV
→ Viti di fissaggio
→ CILINDRO ESCLUSO

Bolt and Latch
2 Turns
Cylinder movement
Round Edge

STANDARD FINISHINGS

→ Front plate, Bolt, Latch OLV

ACCESSORIES

→ Striking plate with tab Art. T357 OLV
→ Fixing screws
→ CYLINDER NOT INCLUDED

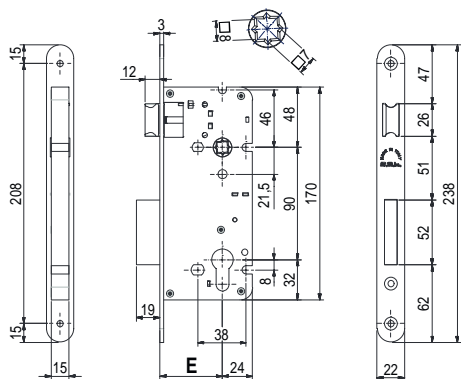

T2210/90

Catenaccio e Scrocco | 2 Mandate | Azionamento a cilindro | Bordo Tondo
Bolt and Latch | 2 Turns | Cylinder movement | Round Edge

Codice Code	Finitura Finishing					
T2210 90 40	7				40	
T2210 90 45	7				45	
T2210 90 50	7	2	22x3x238	90	50	1
T2210 90 60	7				60	
T2210 90 70	7				70	

Finitura Finishing	Finiture Standard Standard Finishings				Finiture Speciali Special Finishings				
	OLV	OS	OCL OCS ONS	OB OGR OGM	PLO	AB SFE	OBL OBS	PVD	XSO INOX

Serie
2200



Serrature da infilare a cilindro
Morice locks for profile cylinder

2216/90

Serratura per bagno
 Doppio quadro 8mm
 Catenaccio e Scrocco
 1 Mandata
 Azionamento quadro 8mm

FINITURA DI SERIE

- Piastra frontale, Catenaccio, Scrocco OLV

DOTAZIONE

- Contropiastra con aletta Art. 357 OLV
- Viti di fissaggio

Bathroom lock
 Double square hole 8mm
 Bolt and Latch
 1 Turn
 Square hole movement

STANDARD FINISHINGS

- Front plate, Bolt, Latch OLV

ACCESSORIES

- Striking plate with tab Art. 357 OLV
- Fixing screws

Serie **2200**



Serrature da infilare a cilindro
 Mortice locks for profile cylinder

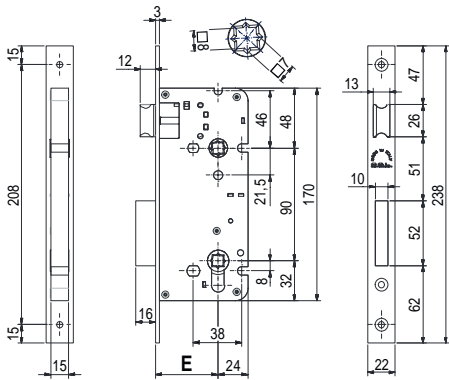
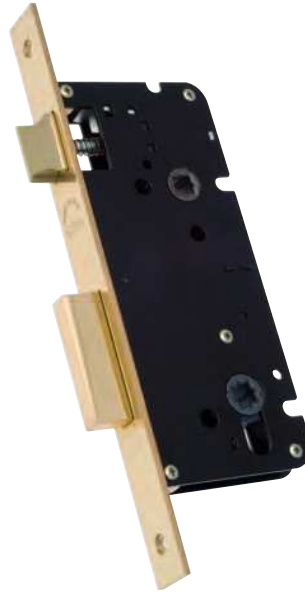

2216/90

Serratura per bagno | Doppio quadro 8mm | Catenaccio e Scrocco | 1 Mandata | Azionamento quadro 8mm

Bathroom lock | Double square hole 8mm | Bolt and Latch | 1 Turn | Square hole movement

Codice Code	Finitura Finishing						
02216 90 40 ___ 7	---						
02216 90 45 ___ 7	---						
02216 90 50 ___ 7	---	1	22x3x238	90			1 20
02216 90 60 ___ 7	---						
02216 90 70 ___ 7	---						

Finiture Standard | Standard Finishings

Finiture Speciali | Special Finishings

Finitura Finishing	OLV	OS	COL OCS ONS	OB OGR OGM	PLO	AB SFE	OBL OBS	PVD	XSO INOX

T2216/90

Serratura per bagno
Doppio quadro 8mm
Catenaccio e Scrocco
1 Mandata
Azionamento quadro 8mm | Bordo Tondo

FINITURA DI SERIE

- Piastra frontale, Catenaccio, Scrocco OLV

DOTAZIONE

- Contropiastra con aletta Art. T357 OLV
- Viti di fissaggio

Bathroom lock
Double square hole 8mm
Bolt and Latch
1 Turn
Square hole movement | Round Edge

STANDARD FINISHINGS

- Front plate, Bolt, Latch OLV

ACCESSORIES

- Striking plate with tab Art. T357 OLV
- Fixing screws

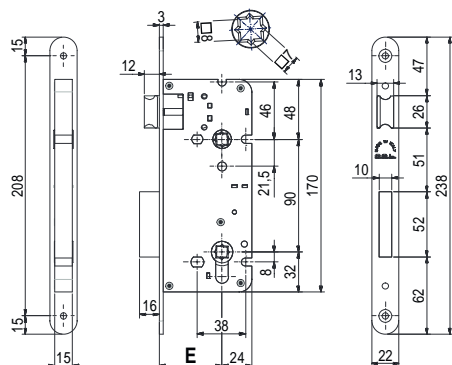
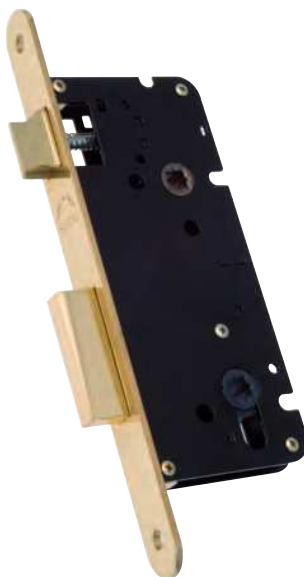

T2216/90

Serratura per bagno | Doppio quadro 8mm | Catenaccio e Scrocco | 1 Mandata | Azionamento quadro 8mm | Bordo Tondo
Bathroom lock | Double square hole 8mm | Bolt and Latch | 1 Turn | Square hole movement | Round Edge

Codice Code	Finitura Finishing						
T2216 90 40 ___ 7	---				40		
T2216 90 45 ___ 7	---				45		
T2216 90 50 ___ 7	---	1	22x3x238	90	50	1	20
T2216 90 60 ___ 7	---				60		
T2216 90 70 ___ 7	---				70		

Finiture Standard | Standard Finishings

Finitura
Finishing

OLV	OS	OCL OCS ONS	OB OGR OGM	PLO	AB SFE	OBL OBS	PVD	XSO INOX

Finiture Speciali | Special Finishings

Serie
2200



Serrature da infilare a cilindro
Morice locks for profile cylinder

2260/90-2265/90

Catenaccio e Scrocco
1-2 Mandate
Azionamento con Chiave Patent

FINITURA DI SERIE

- Piastra frontale, Catenaccio, Scrocco, Chiave OLV

DOTAZIONE

- Contropiastra con aletta Art. 357 OLV
- Viti di fissaggio
- Chiave Art. 384 OLV (Cifratura UNICA)

Bolt and Latch
1-2 Turns
Patent Key movement

STANDARD FINISHINGS

- Front plate, Bolt, Latch, Key OLV

ACCESSORIES

- Striking plate with tab Art. 357 OLV
- Fixing screws
- Key Art. 384 OLV (UNIQUE Code)

Serie **2200**



Serrature da infilare a cilindro
Morice locks for profile cylinder

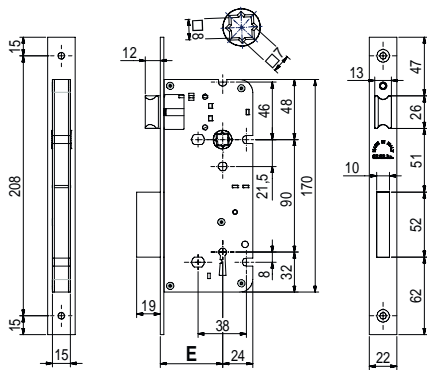
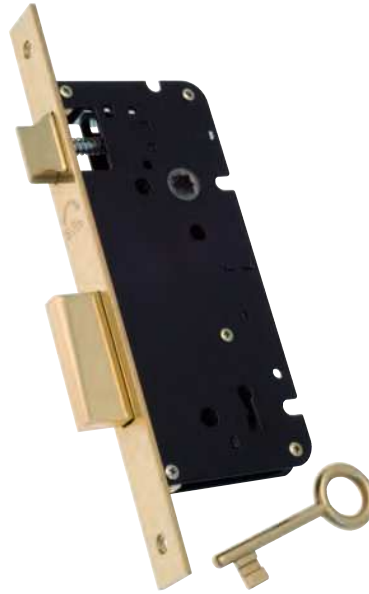

2260/90
2265/90

Catenaccio e Scrocco | 1-2 Mandate | Azionamento con Chiave Patent
Bolt and Latch | 1-2 Turns | Patent Key movement

Codice Code	Finitura Finishing						
02260 90 40 ___ 7							40
02260 90 45 ___ 7							45
02260 90 50 ___ 7		2					50
02260 90 60 ___ 7							60
02265 90 40 ___ 7			22x3x238				40
02265 90 45 ___ 7						1	45
02265 90 50 ___ 7		1					50
02265 90 60 ___ 7							60

Finiture Standard | Standard Finishings

Finiture Speciali | Special Finishings

Finitura Finishing	OLV	OS	OC OCS ONS	OB OGR OGM	PLO	AB SFE	OBL OBS	PVD	XSO INOX

T2260/90-T2265/90

Catenaccio e Scrocco
 1-2 Mandate
 Azionamento con Chiave Patent
 Bordo Tondo

FINITURA DI SERIE

→ Piastra frontale, Catenaccio, Scrocco, Chiave OLV

DOTAZIONE

→ Contropiastra con aletta Art. T357 OLV
 → Viti di fissaggio
 → Chiave Art. 384 OLV (Cifratatura UNICA)

Bolt and Latch
 1-2 Turns
 Patent Key movement
 Round Edge

STANDARD FINISHINGS

→ Front plate, Bolt, Latch, Key OLV

ACCESSORIES

→ Striking plate with tab Art. T357 OLV
 → Fixing screws
 → Key Art. 384 OLV (UNIQUE Code)

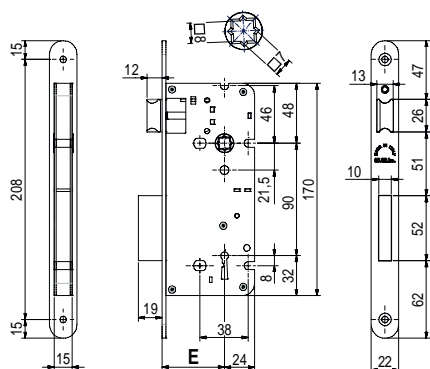
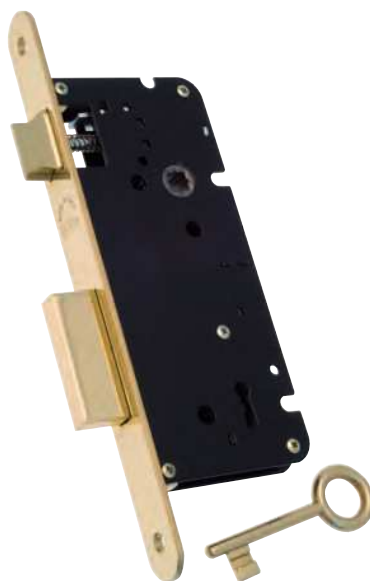

**T2260/90
 T2265/90**

Catenaccio e Scrocco | 1-2 Mandate | Azionamento con Chiave Patent | Bordo Tondo
 Bolt and Latch | 1-2 Turns | Patent Key movement | Round Edge

Codice Code	Finitura Finishing						
T2260 90 40	7						40
T2260 90 45	7	2					45
T2260 90 50	7						50
T2260 90 60	7						60
T2265 90 40	7		22x3x238	90		1	20
T2265 90 45	7						45
T2265 90 50	7	1					50
T2265 90 60	7						60

Finiture Standard | Standard Finishings

Finiture Speciali | Special Finishings

Finitura Finishing	OLV	OS	OCL OCS ONS	OB OGR OGM	PLO	AB SFE	OBL OBS	PVD	XSO INOX

Serie
2200



Serrature da infilare a cilindro
 Mortice locks for profile cylinder

2200/72

Catenaccio Antistrappo e Scrocco

2 Mandate

Azionamento a cilindro

FINITURA DI SERIE

- Piastra frontale, Catenaccio, Scrocco OLV

DOTAZIONE

- Contropiastra con aletta Art. 357 OLV
- Viti di fissaggio
- CILINDRO ESCLUSO

Tamper proof bolt and latch

2 Turns

Cylinder movement

STANDARD FINISHINGS

- Front plate, Bolt, Latch OLV

ACCESSORIES

- Striking plate with tab Art. 357 OLV
- Fixing screws
- CYLINDER NOT INCLUDED

Serie **2200**



Serrature da infilare a cilindro
Morice locks for profile cylinder

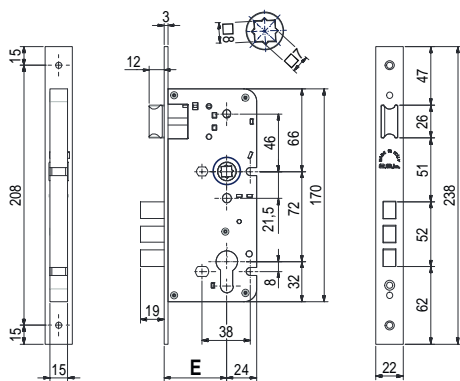
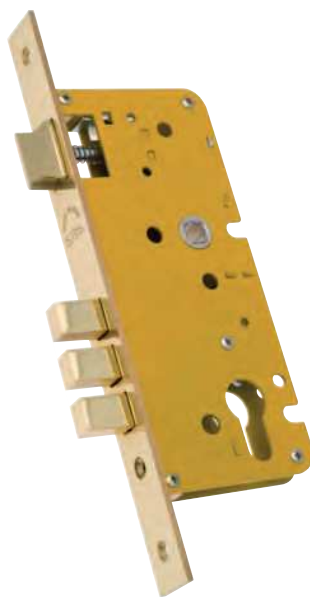

2200/72

Catenaccio Antistrappo e Scrocco | 2 Mandate | Azionamento a cilindro

Tamper proof bolt and latch | 2 Turns | Cylinder movement

Codice Code	Finitura Finishing								
02200 72 45 ___ 7	---								45
02200 72 50 ___ 7	---								50
02200 72 55 ___ 7	---	2	22x3x238	72					55
02200 72 60 ___ 7	---								60
02200 72 70 ___ 7	---								70

Finiture Standard | Standard Finishings

Finiture Speciali | Special Finishings

Finitura Finishing	OLV	OS	OC OCS ONS	OB OGR OGM	PLO	AB SFE	OBL OBS	PVD	XSO INOX

T2200/72

Catenaccio Antistrappo e Scrocco

2 Mandate

Azionamento a cilindro

Bordo Tondo

FINITURA DI SERIE

→ Piastra frontale, Catenaccio, Scrocco OLV

DOTAZIONE

→ Contropiastra con aletta Art. T357 OLV

→ Viti di fissaggio

→ CILINDRO ESCLUSO

Tamper proof bolt and latch

2 Turns

Cylinder movement

Round Edge

STANDARD FINISHINGS

→ Front plate, Bolt, Latch OLV

ACCESSORIES

→ Striking plate with tab Art. T357 OLV

→ Fixing screws

→ CYLINDER NOT INCLUDED

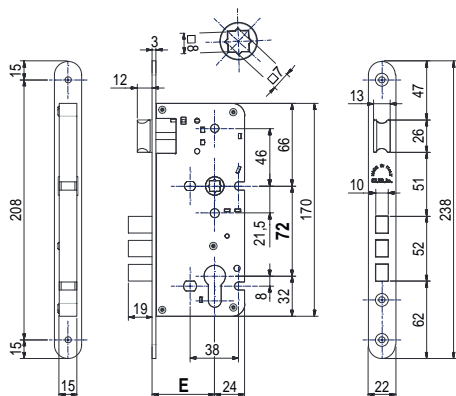
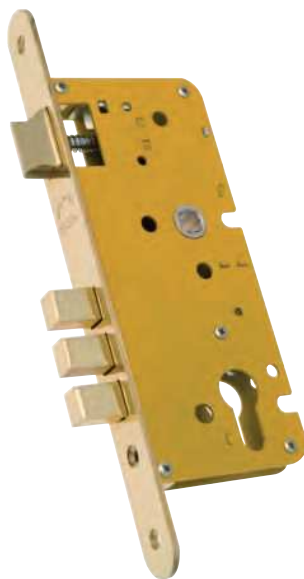

T2200/72

Catenaccio Antistrappo e Scrocco | 2 Mandate | Azionamento a cilindro | Bordo Tondo

Tamper proof bolt and latch | 2 Turns | Cylinder movement | Round Edge

Codice Code	Finitura Finishing						
T2200 72 45	7					45	
T2200 72 50	7					50	
T2200 72 55	7	2	22x3x238	72		55	1
T2200 72 60	7					60	
T2200 72 70	7					70	20

Finitura Finishing	Finiture Standard Standard Finishings				Finiture Speciali Special Finishings				
	OLV	OS	OCL OCS ONS	OB OGR OGM	PLO	AB SFE	OBL OBS	PVD	XSO INOX

Serie
2200



Serrature da infilare a cilindro
Morice locks for profile cylinder

2210/72

Catenaccio e Scrocco
2 Mandate
Azionamento a cilindro

FINITURA DI SERIE

- Piastra frontale, Catenaccio, Scrocco OLV

DOTAZIONE

- Contropiastra con aletta Art. 357 OLV
- Viti di fissaggio
- CILINDRO ESCLUSO

Bolt and Latch
2 Turns
Cylinder movement

STANDARD FINISHINGS

- Front plate, Bolt, Latch OLV

ACCESSORIES

- Striking plate with tab Art. 357 OLV
- Fixing screws
- CYLINDER NOT INCLUDED

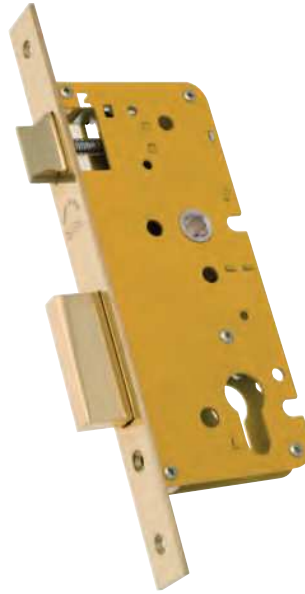

Serie **2200**



Serrature da infilare a cilindro
Morice locks for profile cylinder

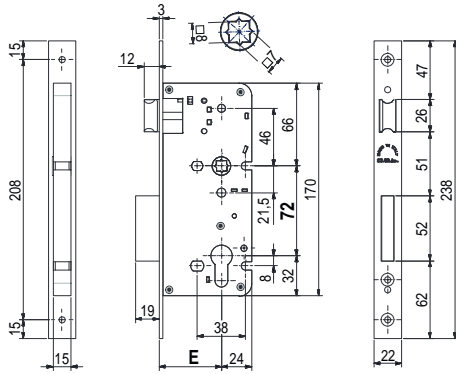

2210/72

Catenaccio e Scrocco | 2 Mandate | Azionamento a cilindro

Bolt and Latch | 2 Turns | Cylinder movement

Codice Code	Finitura Finishing					
02210 72 40 ___ 7	---					
02210 72 45 ___ 7	---					
02210 72 50 ___ 7	---					
02210 72 55 ___ 7	---	2	22x3x238	72		1 20
02210 72 60 ___ 7	---					
02210 72 70 ___ 7	---					

Finiture Standard | Standard Finishings

Finiture Speciali | Special Finishings

Finitura Finishing	OLV	OS	OC OCS ONS	OB OGR OGM	PLO	AB SFE	OBL OBS	PVD	XSO INOX

T2210/72

Catenaccio e Scrocco
2 Mandate
Azionamento a cilindro
Bordo Tondo

FINITURA DI SERIE

→ Piastra frontale, Catenaccio, Scrocco OLV

DOTAZIONE

→ Contropiastra con aletta Art. T357 OLV
→ Viti di fissaggio
→ CILINDRO ESCLUSO

Bolt and Latch
2 Turns
Cylinder movement
Round Edge

STANDARD FINISHINGS

→ Front plate, Bolt, Latch OLV

ACCESSORIES



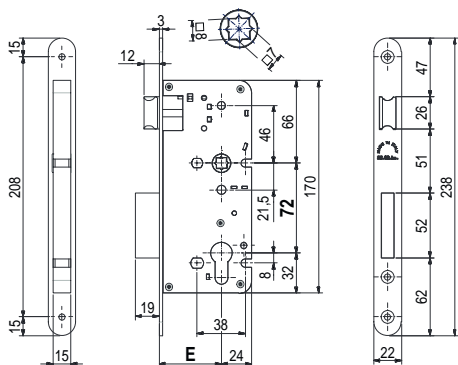
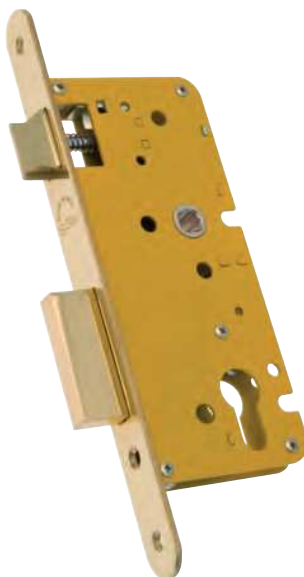



→ Striking plate with tab Art. T357 OLV
→ Fixing screws
→ CYLINDER NOT INCLUDED



T2210/72

Catenaccio e Scrocco | 2 Mandate | Azionamento a cilindro | Bordo Tondo

Bolt and Latch | 2 Turns | Cylinder movement | Round Edge

Codice Code	Finitura Finishing						
T2210 72 40	7						
T2210 72 45	7						
T2210 72 50	7						
T2210 72 55	7	2	22x3x238	72		1	20
T2210 72 60	7						
T2210 72 70	7						

Finitura Finishing	Finiture Standard Standard Finishings				Finiture Speciali Special Finishings				
	OLV	OS	OCL OCS ONS	OB OGR OGM	PLO	AB SFE	OBL OBS	PVD	XSO INOX

Serie
2200



Serrature da infilare a cilindro
Morice locks for profile cylinder

2216/72

Serratura per bagno
 Doppio quadro 8mm
 Catenaccio e Scrocco
 1 Mandata
 Azionamento quadro 8mm

FINITURA DI SERIE

- Piastra frontale, Catenaccio, Scrocco OLV

DOTAZIONE

- Contropiastra con aletta Art. 357 OLV
- Viti di fissaggio

Bathroom lock
 Double square hole 8mm
 Bolt and Latch
 1 Turn
 Square hole movement

STANDARD FINISHINGS

- Front plate, Bolt, Latch OLV

ACCESSORIES

- Striking plate with tab Art. 357 OLV
- Fixing screws

Serie **2200**



Serrature da infilare a cilindro
 Mortice locks for profile cylinder

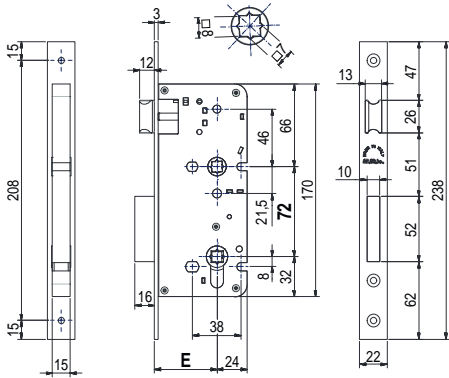
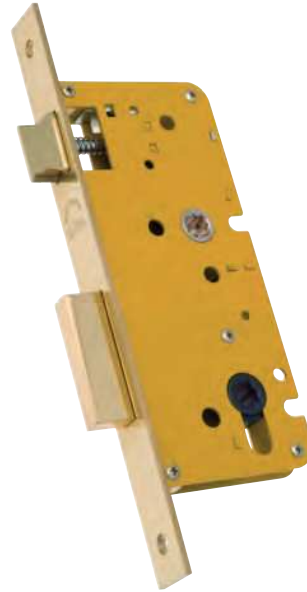

2216/72

Serratura per bagno | Doppio quadro 8mm | Catenaccio e Scrocco | 1 Mandata | Azionamento quadro 8mm

Bathroom lock | Double square hole 8mm | Bolt and Latch | 1 Turn | Square hole movement

Codice Code	Finitura Finishing					
02216 72 40 ___ 7	---					40
02216 72 45 ___ 7	---					45
02216 72 50 ___ 7	---					50
02216 72 55 ___ 7	---	1	22x3x238	72		55
02216 72 60 ___ 7	---					60
02216 72 70 ___ 7	---					70

Finiture Standard | Standard Finishings

Finiture Speciali | Special Finishings

Finitura Finishing	OLV	OS	OCL OCS ONS	OB OGR OGM	PLO	AB SFE	OBL OBS	PVD	XSO INOX

T2216/72

Serratura per bagno
Doppio quadro 8mm
Catenaccio e Scrocco
1 Mandata
Azionamento quadro 8mm | Bordo Tondo

FINITURA DI SERIE

→ Piastra frontale, Catenaccio, Scrocco OLV

DOTAZIONE

→ Contropiastra con aletta Art. T357 OLV
→ Viti di fissaggio

Bathroom lock
Double square hole 8mm
Bolt and Latch
1 Turn
Square hole movement | Round Edge

STANDARD FINISHINGS

→ Front plate, Bolt, Latch OLV

ACCESSORIES



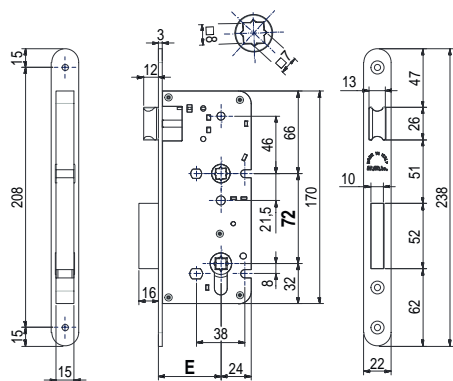
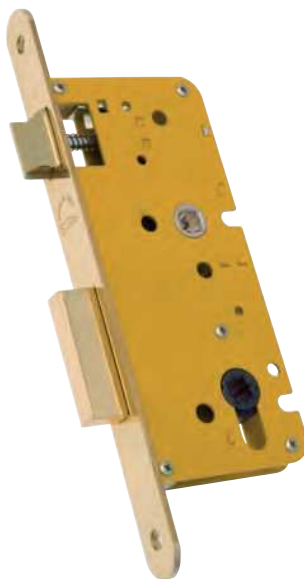



→ Striking plate with tab Art. T357 OLV
→ Fixing screws



T2216/72

Serratura per bagno | Doppio quadro 8mm | Catenaccio e Scrocco | 1 Mandata | Azionamento quadro 8mm | Bordo Tondo

Bathroom lock | Double square hole 8mm | Bolt and Latch | 1 Turn | Square hole movement | Round Edge

Codice Code	Finitura Finishing						
T2216 72 40 ___ 7	---						
T2216 72 45 ___ 7	---						
T2216 72 50 ___ 7	---	1	22x3x238	72		1	20
T2216 72 55 ___ 7	---						
T2216 72 60 ___ 7	---						
T2216 72 70 ___ 7	---						

Finiture Standard | Standard Finishings

Finiture Speciali | Special Finishings

Finitura Finishing	OLV	OS	OCL OCS ONS	OB OGR OGM	PLO	AB SFE	OBL OBS	PVD	XSO INOX

Serie
2200



Serrature da infilare a cilindro
Morice locks for profile cylinder

